

# Imperial

LS™



*High Performance  
Windows and Doors*

# Our Promise to You

Soft-Lite has been manufacturing window products since 1934. During those years many things in our world have changed. However, one thing has remained constant — the desire to own and improve a home to fit one's lifestyle.

Today, "improving your home" does not mean the same thing it did 70 years ago. The continually rising cost of energy has now become a major cost and personal concern to every American citizen. People are rethinking every aspect of their lives in an effort to conserve energy and cut costs. Fortunately, Soft-Lite can help you with this effort.

Using materials and technologies that have improved significantly over the years, Soft-Lite builds one of the most energy efficient and durable windows available today...the Imperial LS™ window. We designed this window to be the most beautiful, best performing window made today. None of the standard, conventional window designs available in the industry met our demanding criteria. So we broke the mold and designed the window for a whole new generation of needs...the Imperial LS™ window.

## Soft-Lite Lifetime Warranty

Our Lifetime Warranty is designed to protect your investment and our reputation. It guarantees that our windows will not rot, rust, warp, pit, corrode or blister, and that our vinyl colors will remain true for the life of your home. Our Lifetime Warranty is non-prorated and is fully transferable. We also warranty all moving parts and the hermetically insulated seal against defects in materials or workmanship. Finally, we offer the ultimate in protection with a lifetime glass breakage rider for extra peace of mind.

# Don't just take our word for it...



Soft-Lite is a member of the Window & Door Dealers Alliance, a networking organization that exclusively serves window and door dealers. The Window & Door Alliance provides the latest information on trends, installation practices, and products. [www.wddalliance.org/index.html](http://www.wddalliance.org/index.html)



Soft-Lite is a member of the Efficient Windows Collaborative (EWC) in which members have made a commitment to manufacture and promote energy-efficient windows. [www.efficientwindows.org](http://www.efficientwindows.org)



The Champion of Industry Award recognizes exceptional achievements and contributions in a wide variety of American corporations. Companies must be considered to be positive "difference makers" within their industry to be selected. [www.championsaward.com](http://www.championsaward.com)



Soft-Lite is a five-time winner of this award. *Window & Door Magazine* gathers a broad range of input to determine the industry's most innovative products, companies, organizations, and technologies. [www.windowanddoor.net](http://www.windowanddoor.net)



Soft-Lite is an Energy Star Partner. Energy Star is a joint program of the U.S. Environmental Protection Agency and the U.S. Department of Energy helping us all save money and protect the environment through energy efficient products and practices. [www.energystar.gov](http://www.energystar.gov)

Soft-Lite products are certified by the National Fenestration Rating Council. NFRC develops and administers comparative energy and related rating programs that serve the public. It provides fair, accurate, credible, and user-friendly information on fenestration product performance. [www.nfrc.org](http://www.nfrc.org)



Soft-Lite products are Gold Label certified by the American Architectural Manufacturers Association (AAMA), the source of performance standards, product certification and educational programs for the window, door and skylight industry. [www.aamanet.org](http://www.aamanet.org)



Manufacturer of Certified Products



In recognition of its dedication to excellence in using the Friedman ERP software system, Soft-Lite has established a web-based integrated ordering platform including Power Bids that delivers accurate quotes and quickens lead times. [www.friedmancorp.com](http://www.friedmancorp.com)



Every year since 1996, Soft-Lite has been placed on the Top 100 Manufacturers' annual list which presents North America's 100 largest manufacturers of residential windows, doors and/or skylights. The Top 100 highlights the activities of the industry's most influential leaders. [www.windowanddoor.net](http://www.windowanddoor.net)



Door and Window Manufacturer

Soft-Lite is a Company to Watch in *Door and Window Manufacturer* magazine. This trade journal annually profiles manufacturers and suppliers who lead the industry in innovation, performance, and professionalism.



The Ohio Partnership for Excellence is a non-profit organization that uses the Malcolm Baldrige Criteria for Performance Excellence to continuously improve manufacturing quality. Soft-Lite is a winner of the prestigious OPE "Commitment to Excellence" Award. [www.opec.org](http://www.opec.org)

# Imperial Double Hung LS™



Our Imperial LS double hung windows bring a whole new set of definitions to the words beauty, comfort, energy efficiency, and durability. Beginning with our sculpted sash design (shown on page 14), our low profile sash locks, and our ergonomically designed sash lift rails, you will begin to see and feel the differences between the ordinary window and the Imperial LS.

One of the most significant energy efficient features is the Ultra-Smart triple-fin weather-strip on both sashes (shown on page 14). This technologically advanced weather-strip dramatically reduces air infiltration into your home. The fully welded corners on the sashes and mainframe prevent air leaks and add durability. Finally, Soft-Lite's huge selection of energy efficient glass packages allows you to fully customize your windows to meet your personal energy efficiency needs (page 12).

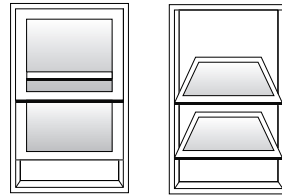

Exterior view

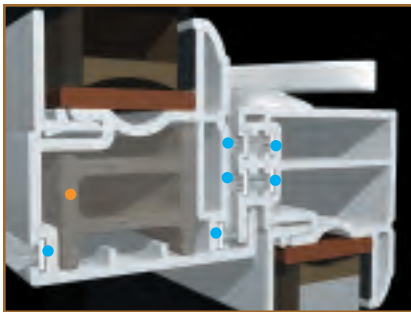

- Ultra-Smart™ triple-fin weatherstripping on all sashes and at interlocking meeting rail.
- K-Beam™ reinforcement at meeting rail for extra strength. (see details on page 15)



Our optional Auto-Majik™ lock ensures that you will never “forget” to lock your windows again. The lock automatically engages as soon as you close the window.



Soft-Vent, when deployed, will limit sash travel to allow for ventilation.



Tight mortise-cut, double-wall sill dam extends inside the jamb, eliminating the need to caulk an open seam.

# Sliders

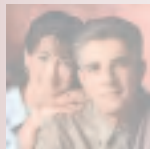

All the same energy efficient and beautiful features which make our double hung windows a superior choice also apply to our slider line.

important. Our traditional slider sashes lift out for easy cleaning.

In addition, tandem brass rollers ensure easy operation of our slider along with a unique sill drainage system which lowers air infiltration and improves comfort.

Consider our traditional slider in areas where a tilt feature is not



Durable brass sash rollers.



Secure locking hardware.



Our optional slide and tilt hardware will allow you to enjoy the benefits of being able to tilt your slider sash in for safe, easy cleaning from inside your home.

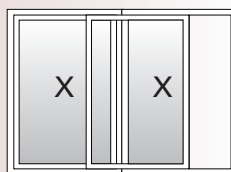

2-lite Slider

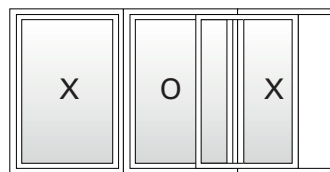

3-lite Slider (fixed center lite)  
1/3-1/3-1/3 configuration (optional)

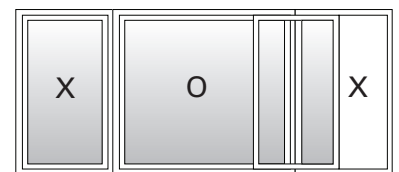

3-lite Slider (fixed center lite)  
1/4-1/2-1/4 configuration (standard)

"O" designates fixed lites. "X" designates operating lites. All views interior. Choose your preference of right-hand or left-hand operating lites.

# Casements, Awnings & Hoppers



Casement windows define a special look and feel for your home. Whether in multi-window configurations or as individual windows, casements, awnings, and hoppers offer many aesthetic choices.

Our single-lever lock handle effortlessly engages and locks multiple lock points within the casement mainframe when closed. Our easy to use, durable, crank handle and hardware assures that you will be able to open and close your casement windows with ease, so that you can enjoy those beautiful days and evenings in style, comfort, and security.



*Robust strength in a low-profile, standard fold-down handle design. Easy to open and close handle and hardware last a lifetime.*



*Hidden corrosion-resistant steel locking claws engage in self-lubricating keepers, ensuring a positive, secure and weather-tight seal.*



*Multi-point lock activator engages or disengages multiple sash locks with one easy single lever design.*

Imperial LS Casement windows offer industry-leading AAMA GOLD LABEL CERTIFIED performance and one of the best NFRC Rated U-factors in the window business.

Air: .02 cfm at 25 mph  
 Water: DP65 at 62 mph at 8" rain per hour  
 Design Pressure: DP60 at 187 mph windload  
 Thermal NFRC Tested:  
 .16 U-factor with Ultimate glass



*New invisible retention hardware system eliminates unsightly screen clips used on traditional casements.*

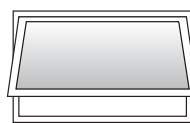

Awning exterior view



Hopper interior view

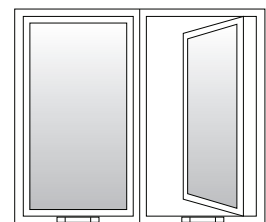

Casement interior view

Our casement windows open a full 90° for easy cleaning of both the inside and outside. (Egress hardware optional)

# Bows, Bays & Gardens



Thinking of a room addition? Consider a stunning new bay or bow window. Or, for baths and kitchens, include our beautiful garden window in your plans. No other window style will actually change the look and feel of a room like a bay, bow or garden window — at a fraction of the cost of a major remodeling job.

Your Imperial LS bay, bow or garden window will come packed with features other manufacturers omit or charge extra for. We include an R-9 Super-Seat™ that features high-density polyisocyanurate foam to fight condensation and energy loss. The seat comes standard in white birch, with options including oak, a variety of laminates, Corian®, and custom matching stains and varnish.

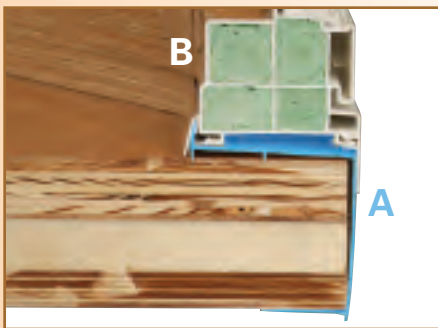

- A. Exclusive welded sill pan (highlighted in blue) eliminates water penetration. The unique design provides a built-in weep system and a smooth finish on the exterior surface of the seat board.
- B. All window and mull cavities are insulated completely with Comfort-Foam™ for maximum energy efficiency.

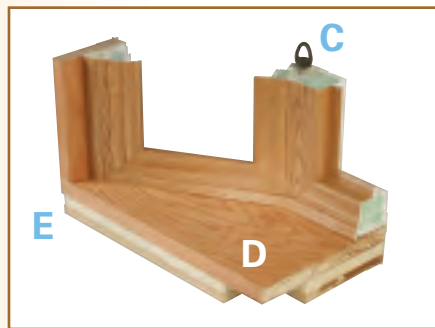

- C. Threaded steel rod and chain bracing system provides sag-free support. (Knee brackets must be installed if roof overhang prevents use of chain system.)
- D. Factory finished interior edge banding is beautiful protection for your Super-Seat™.
- E. 1.25" thick furniture grade hardwood.

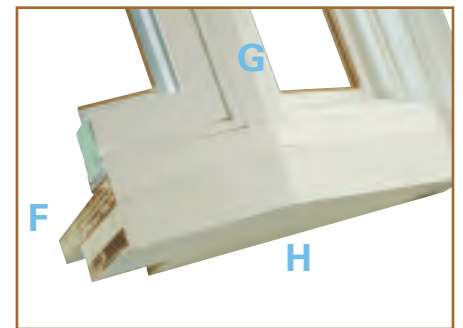

- F. Insulated seatboard with 3/4" exterior capped plywood. Super Seat™ Dow® Foam 3" thick sandwich with R-9 performance for maximum thermal protection; also fights condensation.
- G. Mull cover plates ensure no butt-joints to caulk or leak.
- H. Factory-capped underside: beautiful lines, consistent water shed.



Each mullion and window frame is also fully Comfort-Foam™ insulated for maximum energy savings, the highest possible!

Of course, you have your choice of operating or fixed casement windows or double hung windows in your bay or bow.

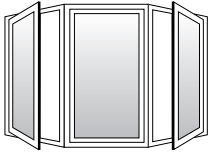

3-lite Bay exterior  
10°, 15°, 30° and 45° Bay

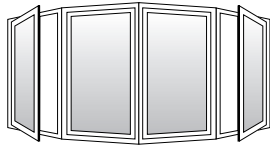

4-lite Bow exterior  
10° and 15° Bow

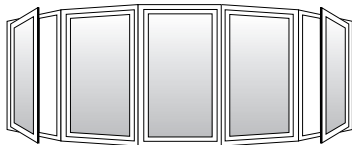

10° 5-lite Bow exterior

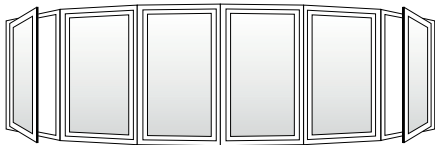

10° 6-lite Bow exterior



Our Garden Vue™ window is designed to combine the aesthetic appeal of clean lines with a structural design that assures lasting durability. It features specially-built trapezoidal operating side casement windows that open wide to let you enjoy the outdoors from the comfort of your home. Full trapezoidal screens cover the interior openings. Dual compression seals and locking hardware on the casements provide air and water tightness while weep channels at the window's top and bottom keep the interior dry. The Garden Vue™ window comes standard with adjustable height, PVC-coated shelves or optional glass shelves.



Optional glass shelf

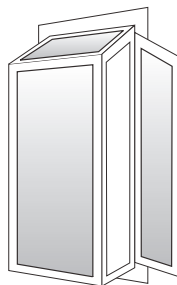

Exterior view.  
Window opens to a wide 70 degree angle.



# Special Shapes

For uniquely shaped openings we offer special shapes with matching frame profiles and glass options. All special shapes are custom built, like all of our windows, to your specifications.



Circle Top



Circle Top EL



Full Circle

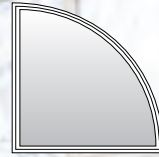

Quarter Circle



Quarter Circle EL

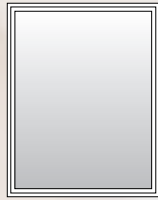

Rectangle



Pentagon



Pentagon Extended Leg



Pentagon Left (Right available)



Trapezoid Left (Right available)



Octagon



Octagon EL



Hexagon



Hexagon EL



Triangle with Equal Sides



Eyebrow

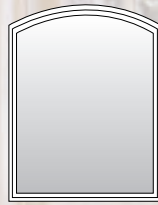

Eyebrow EL



Half Eyebrow



Half Eyebrow EL



Triangle Left (Right available)



Triangle EL

## MINIBLINDS BETWEEN THE GLASS

*Never clean miniblinds again. All patio doors and windows (except awning windows and most special shapes) are available with internal miniblinds in a tilt-only option. Certain restrictions apply. Available in white or beige.*





# Thermal Glide™ Doors

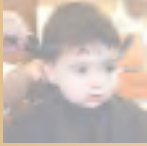

Our popular Soft-Lite Thermal Glide™ patio door is the work-horse of the industry. It comes fully loaded with state-of-the-art features such as: Soft-Lite weather-stripping, which incorporates anti-mold, -mildew and -fungus properties; a sliding screen door that resists twisting, warping and “rack jumping”; an extremely durable fiberglass threshold that won’t rot or warp; and an AAMA air infiltration rating of .09cfm at 25mph, which is 20 times better than industry standards.

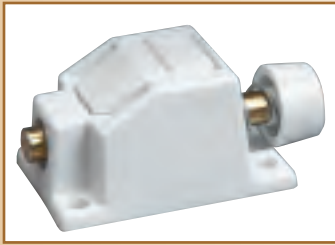

Our optional heavy-duty patio door vent stop adds security while allowing ventilation.

To ensure your Thermal Glide patio door will fit perfectly and operate exactly as designed, the frame and sashes are welded at the plant and all two-panel doors are shipped fully assembled. The center panel of a three-panel door is packaged separately to prevent shipping damage.



Heavy duty brass rollers provide smooth operation.



The screen door is built to remain strong and resist rack jumping.

## Standard Single-Lock Handles



Standard single-lock handles come in powder coated paint colors of White, Cream-White, Beige and Brown.

## Optional Legacy Single-Lock Handles



Optional Legacy Lock color options include your choice of Brass, Antique Brass and Nickel.

## Optional Multi-Point Secure Locking Handles



Brass

Nickel

Our optional deluxe handles provide multi-point locking security by locking the door in four locations. The locks are made from zinc in order to protect against corrosion while still maintaining structural strength (all of the internal springs are made from stainless steel).

# Patio Door Configurations



5'0" x 6'8"

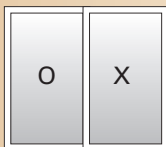

6'0" x 6'8"

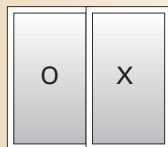

8'0" x 6'8"

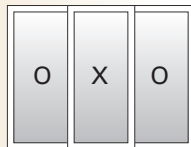

9'0" x 6'8"



12'0" x 6'8"

“X” designates operating panel.  
“O” designates fixed panel.

All perspectives viewed from **OUTSIDE** looking in.

Choose your preference of right-hand or left-hand operating panels.

# Color Options



## VINYL COLOR OPTIONS

Some houses just demand a specific color of window — as with this Tudor style house! Painted wood windows are now a thing of the past! Today you can replace them with extremely energy efficient Imperial LS windows in any custom exterior color you choose!

### Interior/Exterior Vinyl Colors



\*Not available with exterior foil laminates. Also not available in Garden windows.

### Interior Woodgrain Colors\*



### Sure-Coat™ Standard Exterior PVC Bond Colors



### Exterior Foil Laminates\*



\*Garden Windows not available in Exterior Foil Laminates.

# Decorative Grids



Flat grids

Contour grids

Flat and contour grids offered in a variety of options. Actual color samples may vary from printed brochure. Grid patterns vary based on size and configuration of window. See your Soft-Lite Dealer for more precise color representations and configuration availability.

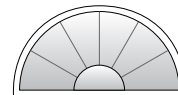

Sun Burst (flat only)

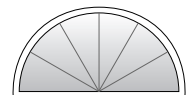

Star Burst (flat and contour)

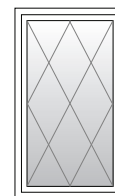

Diamond (flat only)

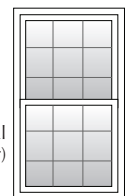

Colonial (flat and contour)

# Air Infiltration Comparison

## Why Do Windows Leak Air?

Poorly designed windows don't have the built-in airlocks, weather stripping, and barriers necessary to keep air from forcing its way in. Without these design features air will push between the sash meeting rails and around the sash perimeter.

We know how uncomfortable a home with leaky windows is. So, to keep you comfortable, we loaded the Imperial LS window with weather barriers that go far beyond the industry standard and other manufacturer's window designs. The LS window is so superior that it leaks only a fraction of what all other typical vinyl and wood windows leak.



The Imperial LS window has earned the prestigious Gold Label Certification for air performance.

## AREAS OF AIR INFILTRATION

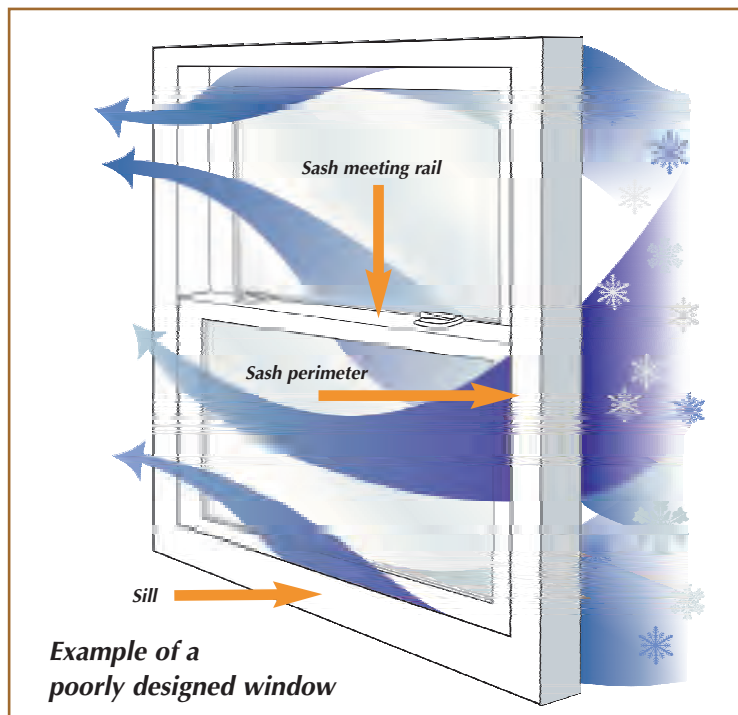

## AIR INFILTRATION COMPARISON CHART

CFM (Cubic feet per minute)	=	GALLONS	=	12 OZ. SODA CANS
<b>Imperial LS</b> <b>.02 CFM</b> of air leakage per minute		 <b>0.15 gallons</b> of air leakage per minute		 <b>1.6 soda cans</b> of air leakage per minute (19.2 oz/min)
<b>Traditional Vinyl Residential High Performance Double Hung Windows</b> (Alside/Simonton/Champion) <b>.15 CFM</b> avg. air leakage per minute Industry Average Range from 0.11CFM to 0.21CFM*		 <b>1.125 gallons</b> of air leakage per minute		 <b>12 soda cans</b> of air leakage per minute (144 oz/min)
<b>At the above rate Imperial LS windows are over 7 times more air tight than traditional vinyl residential high-performance double hung windows.</b>				
<b>Traditional Wood Residential Double Hung Windows</b> (Pella/Marvin/Jeld-Wen/Andersen) <b>.23 CFM</b> avg. air leakage per minute Industry Average Range from 0.12CFM to 0.30CFM*		 <b>1.725 gallons</b> of air leakage per minute		 <b>18.4 soda cans</b> of air leakage per minute (220.8 oz/min)
<b>At the above rate Imperial LS windows are over 11 times more air tight than traditional wood residential double hung windows.</b>				
<b>Industry Standard**</b> <b>.30 CFM</b> of air leakage per minute		 <b>2.25 gallons</b> of air leakage per minute		 <b>24 soda cans</b> of air leakage per minute (288 oz/min)

\*References valid as of October 1, 2010 based on our competitors' websites and independent testing.

\*\*Industry Standard: AAMA (American Architectural Manufacturers Association) has set the Industry standard for Maximum Allowable Air Infiltration at .30 CFM (Cubic feet per minute) during a 25 mph wind. This is equal to 2.25 gallons or 24 soda cans of air leaking through the window every minute!

**Consider this: You would need to combine 23 Imperial LS windows to get as much air leakage as two traditional wood residential double hung windows, and 15 Imperial LS windows to get as much air leakage as two traditional vinyl high-performance double hung windows.**

# Performance and Energy Efficiency

## Energy Efficient Glass

All of our glass packages exceed industry standards for energy efficiency. They all reduce noise and fabric fading, and are warranted for a lifetime against seal failure.

In addition to these qualities, however, we offer a variety of options that allow you to custom tune your windows to your needs and budget. For instance, we offer Intercept® as a reliable energy efficient spacer. As an upgrade you can choose Super Spacer®, the world's only 100% foam, metal free, warm

edge spacer. Super Spacer provides exceptional insulating qualities and reduction in condensation build-up.

Four of our popular glass packages are described below. We offer many others. Please ask your Imperial LS window consultant for more information about the features of the numerous glass packages we offer.



**NFRC WINDOW LABELS**  
All NFRC labels refer to whole window performance, not just the insulated glass unit.

## Double-Pane with Intercept® spacer

- 7/8" insulated glass with argon gas
- Center of Glass (COG): R-3.84, U-value .26

### OPTIONAL:

- Solar low-e: SB70 XL®

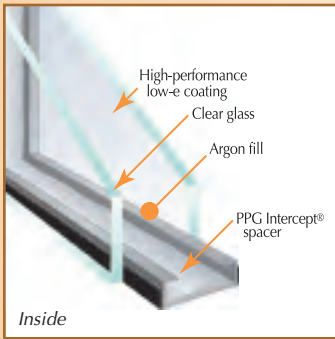

This window is Energy Star qualified in North, North-Central, and South-Central zones. Upgrade of Solar Low-e qualifies window in South zone and provides U-factor: 0.29; SHGC: 0.20; and Visible Transmittance: 0.46.

Double-Pane Intercept® window label

ENERGY STAR® Qualified in Highlighted Regions	
VINYL DOUBLE HUNG IMPERIAL LS Double-Pane, Intercept® Spacer, Argon Fill, Low-E	
ENERGY PERFORMANCE RATINGS	
U-Factor (U.S.I.P.) <b>0.29</b>	Solar Heat Gain Coefficient <b>0.28</b>
ADDITIONAL PERFORMANCE RATINGS	
Visible Transmittance <b>0.51</b>	Condensation Resistance <b>53</b>

## Ultra™ Glass Triple-Pane with Intercept® spacer



- 1" insulated glass with argon gas in both chambers.
- Center of Glass (COG): R-6.66, U-value .15

### OPTIONAL:

- Solar low-e: SB70 XL®

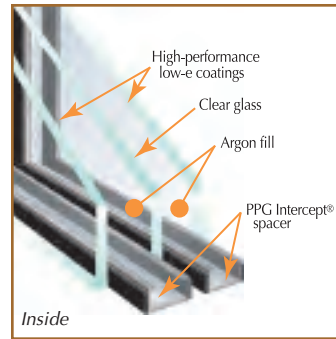

This window is Energy Star qualified in ALL climate zones. NO UPGRADE NEEDED.

Ultra™ window label

ENERGY STAR® Qualified in Highlighted Regions	
VINYL DOUBLE HUNG IMPERIAL LS Triple-Pane, Intercept® Spacer, Argon Fill, Low-E	
ENERGY PERFORMANCE RATINGS	
U-Factor (U.S.I.P.) <b>0.23</b>	Solar Heat Gain Coefficient <b>0.24</b>
ADDITIONAL PERFORMANCE RATINGS	
Visible Transmittance <b>0.40</b>	Condensation Resistance <b>62</b>

## Double-Pane with Super Spacer®

- 7/8" insulated glass with argon gas
- Center of Glass (COG): R-3.84, U-value .26

### OPTIONAL:

- Solar low-e: SB70 XL®

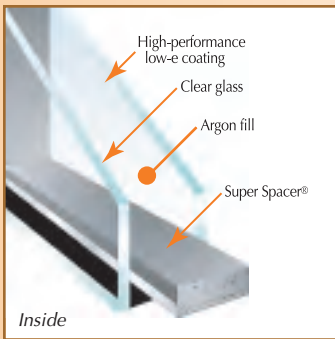

This window is Energy Star qualified in North, North-Central, and South-Central zones. Upgrade of Solar Low-e qualifies window in South zone and provides U-factor: 0.27; SHGC: 0.20; and Visible Transmittance: 0.46.

Double-Pane Super Spacer® window label

ENERGY STAR® Qualified in Highlighted Regions	
VINYL DOUBLE HUNG IMPERIAL LS Double-Pane, Super Spacer®, Argon Fill, Low-E	
ENERGY PERFORMANCE RATINGS	
U-Factor (U.S.I.P.) <b>0.27</b>	Solar Heat Gain Coefficient <b>0.28</b>
ADDITIONAL PERFORMANCE RATINGS	
Visible Transmittance <b>0.51</b>	Condensation Resistance <b>58</b>

## Ultimate™ Glass Triple-Pane with Super Spacer®



- 1" insulated glass with two panes of low-e coating and one pane of clear glass with krypton gas in both chambers.
- Center of Glass (COG): R-10, U-value .10

### OPTIONAL:

- Solar low-e: SB70 XL®

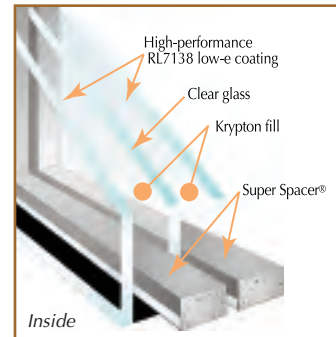

This window is Energy Star qualified in ALL climate zones. NO UPGRADE NEEDED.

Ultimate™ window label

ENERGY STAR® Qualified in Highlighted Regions	
VINYL DOUBLE HUNG IMPERIAL LS Triple-Pane, Super Spacer®, Krypton Fill, Low-E	
ENERGY PERFORMANCE RATINGS	
U-Factor (U.S.I.P.) <b>0.17</b>	Solar Heat Gain Coefficient <b>0.24</b>
ADDITIONAL PERFORMANCE RATINGS	
Visible Transmittance <b>0.40</b>	Condensation Resistance <b>72</b>

## THERMAL PERFORMANCE

The National Fenestration Rating Council (NFRC) label on your windows is specific to the overall thermal performance of the specimen window tested by NFRC ([www.nfrc.org](http://www.nfrc.org)).



**U-Factor** – The lower the U-Factor the better the window's overall thermal performance. The glass package, the window's material, and its components all affect the rating.

### Solar Heat Gain Coefficient –

A measurement of how well products block heat caused by sunlight. The rating is expressed as a number between 0 and 1. The lower the number the better.

**Visible Transmittance** – A measurement of how much light comes through the window. Expressed as a number between 0 and 1, the higher the VT the better.

**Condensation Resistance** – A measurement of how well the window resists condensation on the glass. The higher the number the better.



### NFRC THERMAL TEST RESULTS for THERMAL PERFORMANCE

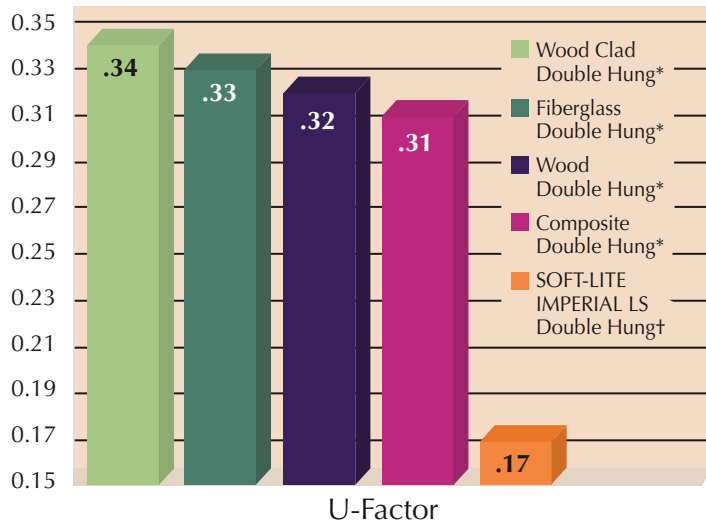

\* No Triple Pane glass

† Ultimate triple-pane with low-e (2), low-e (5) and Super Spacer®

## STRUCTURAL DESIGN PERFORMANCE

The American Architectural Manufacturers Association (AAMA) is the nationally recognized accrediting source for structural design performance of windows and doors. If you demand windows and doors that meet stringent performance standards, just look for the AAMA Certification Label. Products that have earned the right to display this label have had a sample unit pass independent laboratory tests, and only products that bear this prestigious label are certified by the manufacturer. Plus, production lines for windows and doors in the AAMA Certification Program are subject to two unannounced annual inspections. ([www.aamanet.org](http://www.aamanet.org))



### AAMA GOLD LABEL CERTIFICATION for AIR PERFORMANCE

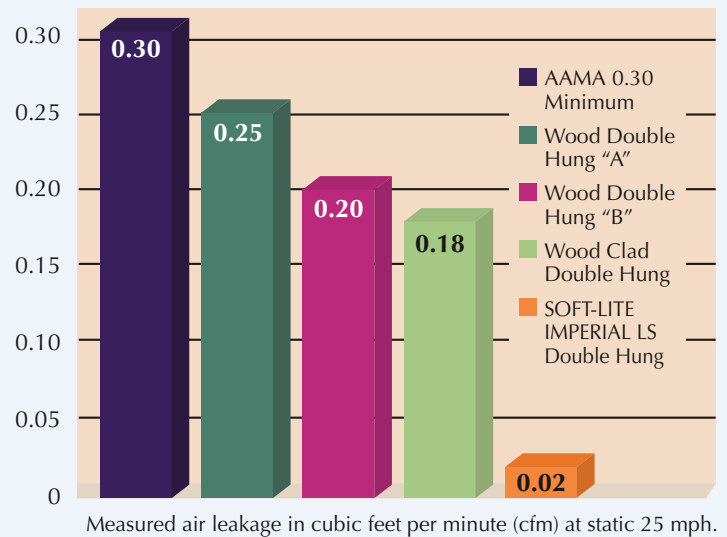

### AAMA PERFORMANCE RATINGS

AAMA Criteria	Industry Minimum	Soft-Lite Imperial LS	Results
AIR w/Automajik Lock	.30 .30	.02 .11	15 x better 2.7 x better
WATER	33 mph	56 mph	70% better
STRUCTURAL LOAD	94 mph	195 mph	2 x better

See page 11 for a detailed explanation of how Imperial LS out-performs other manufacturer's windows in air infiltration resistance.



We also offer combinations of two different low-e glass options. RL7138 Low-e reflects indoor heat back into your home, while SolarBan70XL® reflects heat from the sun back outside.

SolarBan70XL® provides fade protection for all your home furnishings. UV light is responsible for up to 40% of fading damage. Now you can protect your furnishings and carpet with SolarBan70XL®, which blocks 94% of all harmful ultraviolet light.

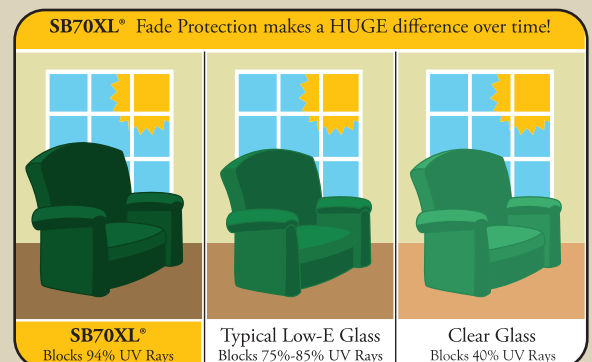

SolarBan70XL® offers the best performance for fade control.

# Technical Information

## WHAT MAKES SOFT-LITE IMPERIAL LS™

**WINDOWS BETTER?** Shop and compare. We think you will see why Soft-Lite Windows are one of the best investments for your home. **Technology, engineering, craftsmanship, robotic precision manufacturing, and people who care** about every single window we make means that we will manufacture only the best for you.

## uPVC FRAMES AND SASHES

All of our windows are made using the finest quality, specially blended, un-plasticized poly vinyl chloride, or uPVC, frames and sash. Your window frame and sash material will **never rot like wood windows** and will **never corrode like metal windows**. uPVC is good for the environment because it saves energy better than other materials. It never needs refinishing (no need to use environmentally harsh varnishes or stains) and it lasts much longer than wood or other materials. This inherent durability means that the likelihood of having to replace your uPVC windows again in the future is much less than if you used wood or metal.



It is also important that you choose **WELDED vinyl windows** because the corners are **permanently fused** together and **will never separate**. Many vinyl windows today are screwed or stapled at the corners just like wood or metal windows. Some are welded on very old, single- or double-weld machines. The corners can separate and leak air and water. Choose only fusion welded vinyl produced with robotic, 4-point welding equipment.

## COMFORT-FOAM™ INSULATION

*(depicted in illustration at right)*

Using our CFC-free, environmentally-friendly Comfort-Foam™ insulation within the cavities of the vinyl frames saves even more energy. This means **less energy use, lower monthly fuel bills, and a step towards saving the Earth's resources**.

## ULTRASmart™ WEATHERSTRIPPING

Ultrafab® Tri-Fin® Gold Series weatherstripping with built-in Ultra-Fresh® antimicrobial protection minimizes

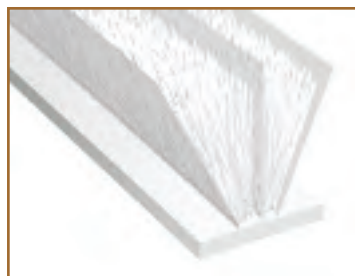

drafts, dust, and pollen and fights the growth of mold and bacteria on the weatherstripping material.

600 inches of UltraSmart™ weatherstripping is used in an average sized double hung window.

## INSULATED GLASS PACKAGES

Our technologically-advanced, insulated glass packages offer a choice of insulating performance which can be tailored to your geographic location. The finest in multiple layered glass and argon or krypton insulating gas, along with super energy efficient “warm edge” sealing technology, **assure maximum energy savings and resistance to condensation**.

## DOUBLE HUNG SILL/SASH PROFILE

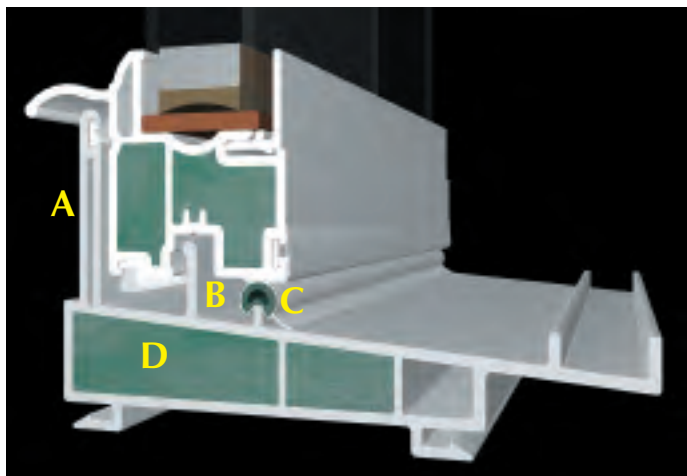

- A. A unique sill dam which extends into the window mainframe for uniform strength and seal.
- B. Our interlocking sill-sash rail keeps the sash in place against the sill dam weatherstrip when the window is under extreme wind-load stress.
- C. Our Q-Ion® compression gasket system straddles the sill rail when the sash is locked shut to add barriers and diversions for exceptional water resistance.
- D. Comfort-Foam™ insulation improves energy efficiency.



In addition to being energy conscious, Soft-lite works to be a good steward of the earth by minimizing waste and recycling all scrap materials in its state-of-the-art, automated robotics manufacturing plant. When you purchase Soft-Lite windows, you'll know you're doing something good for yourself, your family, and the environment.

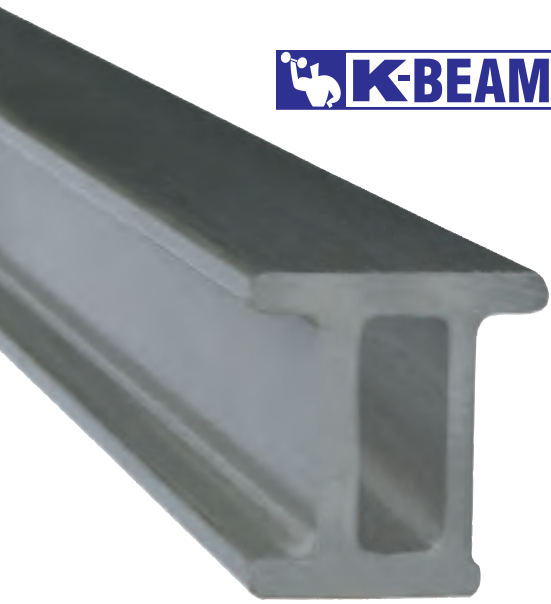

### COMPOSITE SASH RAIL REINFORCED WITH KEVLAR®

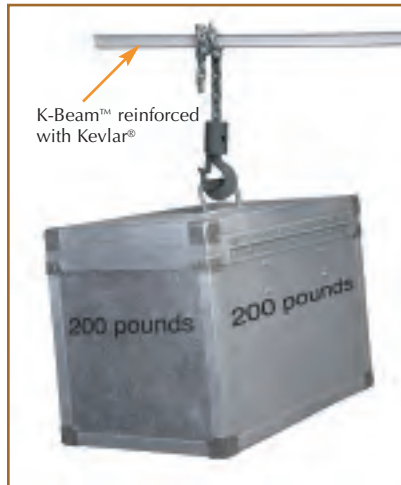

Patent-pending K-Beam™ features DuPont® Kevlar® that is also used to make bullet-proof vests and in Mars Pathfinder ropes, U.S. Navy mooring ropes, jet engine shields, run-flat tires, safety gloves for glass and metal factories, kayaks, skis, helmets, racquets and lots more.

#### K-BEAM™ STRENGTH

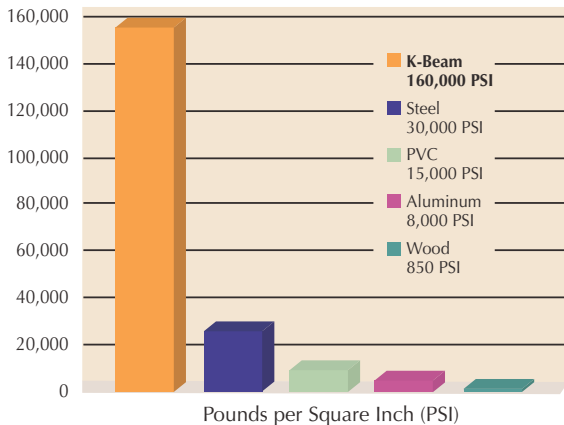

K-Beam™ is over **5 times stronger** than steel. It is also more than **700 times warmer** than aluminum, which means that it blocks the transfer of heat and cold 700+ times better than aluminum.

### BETTERVUE SCREENS™

All Imperial LS windows and Thermal-Glide™ patio doors are available with optional Bettervue™ high-definition, fiberglass insect screening. Bettervue™ screens provide improved light transmittance and airflow while increasing insect protection. Bettervue screens are easier to look through from the inside and they provide better curb appeal from the outside.

We reinforce the sash keeper rail in our double hung and slider windows with K-Beam™, a unique resin-based glass-filled composite material. K-Beam utilizes Kevlar® fibers for additional **strength and the lowest thermal conductivity** which means **extra energy efficiency**. Most manufacturers of vinyl windows today use aluminum or steel to reinforce their vinyl. These products work like a thermal short circuit due to the poor thermal properties of the metal. K-Beam™, our advanced composite reinforcement with Kevlar®, assures **maximum strength, energy efficiency and durability** for the life of your home.

### ENDURA-FORCE™ BALANCE SYSTEM

When you choose a double hung window configuration there are additional features to look for. A sash can be moved up and down for ventilation purposes. Insulated glass is heavy, especially if you are using the higher insulating and more energy efficient triple pane glass combinations of today. Balance hardware is used to help offset the sash weight so that a homeowner can operate their window with ease.

There are several balance types in use today. It's important to know the differences because they can make a big impact on how smoothly your windows operate over time. Soft-Lite uses a **new, heavy-duty, constant-force balance**. Our balance is a **Teflon®-coated, stainless steel coil** protected inside a thermal housing which makes it **strong, silent, and thermally superior**.

With a 3/4" inch steel band width and a fully encapsulated thermal chassis that resists dirt and dust accumulation, our Endura-Force™ balance system will give you decades of **effortless, maintenance-free operation**. Spiral balances are a thing of the past. Block and tackle balances depend on a string, a spring, and pulleys that are housed in a metal chassis. The metal reduces the thermal performance ability of the window they are in. These are among the reasons we developed the Endura-Force™ system and made it a standard part of every Imperial LS double hung window.



Endura-Force™ Teflon®-coated AAMA class 3 stainless steel coil.

3/4-inch width is more durable and supports heavier sashes than weaker 1/2-inch width.

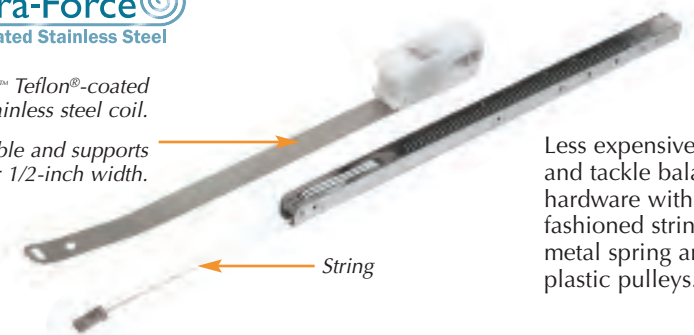

Less expensive block and tackle balance hardware with old-fashioned string, metal spring and plastic pulleys.

# Imperial



[www.NewWindEnergy.com](http://www.NewWindEnergy.com)



*Bringing quality to light.*

[www.soft-lite.com](http://www.soft-lite.com)

Printed by Knepper Press, an



*Imperial* *Authorized Dealer*



LITSL-IMPLS (rev 02/2011)

© 2011 Soft-Lite L.L.C. Printed in U.S.A. Specifications subject to change without notice. All photos and illustrations are property of Soft-Lite L.L.C. unless otherwise indicated. Soft-lite® is a registered trademark of Soft-Lite L.L.C. Imperial LS™, Sure-Coat™, Ultimate™, Ultra™, Thermal Glide™, Soft-White™, Comfort-Foam™, UltraSmart™, Endura-Force™, Auto-Majik™ and K-Beam™ trademark of Soft-Lite L.L.C. Super Spacer® is a registered trademark of Edgetech I.G. Inc. Kevlar®, Corian® and Teflon® are registered trademarks of DuPont®. Intercept®, SolarBan70XL® and SB70XL® are registered trademarks of PPG Industries. Q-lon® is a registered trademark of The Schlegel Group. Comfort-Foam™, UltraSmart™, Endura-Force™, Auto-Majik™ and K-Beam™ are trademarks of Soft-Lite L.L.C. Ultrafab® and Tri-Fin® are registered trademarks of Ultrafab, Inc. Ultra-Fresh® is a registered trademark of Thomson Research Associates, Inc. Super Seat™ is a trademark of Dow®.